

Allia

USER GUIDE

ASAT402ZB | Smart thermostat



THE 360° COMFORT EXPERIENCE

CONGRATULATIONS!

You've entrusted your home's heating to the Allia smart thermostat.

From this point on, your family's comfort is in your hands. Elegant, precise and efficient, your new Allia smart thermostat will help you reduce your electricity bill and ecological footprint while helping safeguard the environment.

Create your own home ecosystem and take full control of your comfort with the Allia mobile app.

DESIGNED AND DEVELOPED FOR NORTH AMERICA

Established in Quebec, Canada for over 35 years, Stelpro understands the special needs of our climate as well as Americans' safety and environmental protection concerns.

By choosing Stelpro's Allia, you are encouraging local innovation and the development of energy-efficient products for a better future.



CONTENTS

4	COMPATIBILITY	
4	WHAT'S IN THE BOX AND REQUIRED TOOLS	
5	WARNING	
6	BEFORE YOU GET STARTED	
	Where to set up your hub	6
	Where to install your thermostats	7
8	INSTALLATION	
	Turning the power off	8
	Attaching the mounting plate	8
	Connecting the electrical wires	9
	Attaching the thermostat to the mounting plate	10
	Turning the power back on	10
11	THERMOSTAT INTERFACE	
12	USE	
	Navigating the advanced menus	12
	Navigating the technical menus	13
	Adjusting the setpoint temperature	13
14	CONNECTION	
	Allia hub	14
	Connecting via the Allia app	14
	Connecting via the Allia hub	15
	Connecting to another Zigbee network	15
16	SETUP	
	Temperature display unit	16
	Heating mode	16
	Lobby mode	17
	Keypad lock/unlock	17
	Open window detection	17
	Backlighting	18
	Thermostat reset	18
19	TROUBLESHOOTING	
21	TECHNICAL SPECIFICATIONS	
22	WARRANTY	

COMPATIBILITY

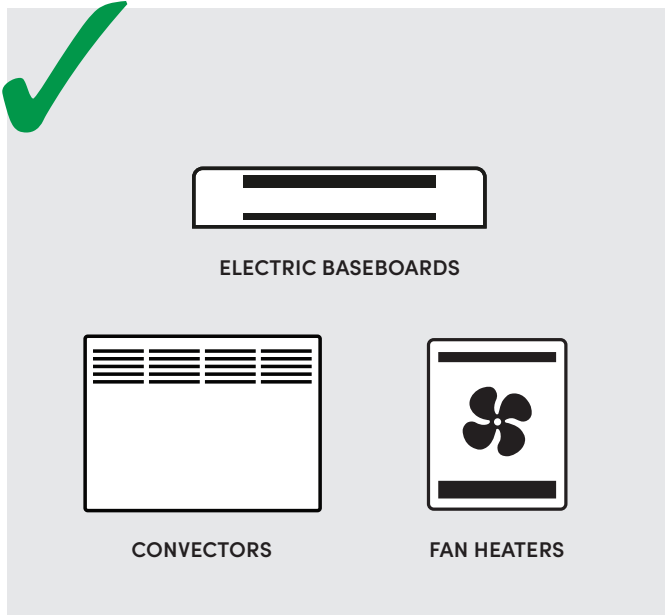

WARNING: This thermostat is not compatible with:

- inductive load systems
- central heating systems
- resistive load systems:
 - less than 150 W and 120 VAC /260 W and 208 VAC /300 W and 240 VAC
 - greater than 2000 W and 120 VAC /3400 W and at 208 VAC /4000 W and at 240 VAC

See page 21 for the Allia thermostat's detailed technical specifications.

WHAT'S IN THE BOX AND REQUIRED TOOLS

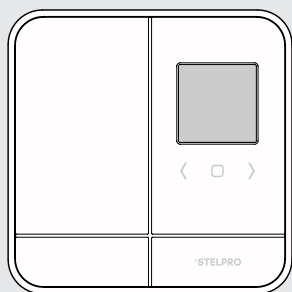

ALLIA THERMOSTAT

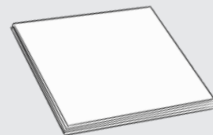

QUICK START GUIDE

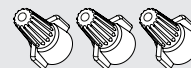

CONNECTION CAPS (3)

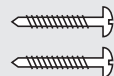

MOUNTING SCREWS (2)

You will need a #2 Phillips screwdriver to install the thermostat.

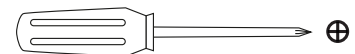

WARNING

Before you get started, take a few minutes to read this guide and watch the Allia thermostat's step-by-step installation video to ensure a safe and easy installation.

VIDEO: stelpro.com/en/allia

Before installing or using the thermostat, the homeowner and installer must read and understand these instructions and keep them for future reference. The manufacturer will assume no responsibility and the warranty will be void if the installer or user does not follow them. Failure to follow these guidelines could result in property damage, injury, burns, and potentially fatal electric shock. Electrical connections must be made by a qualified electrician in accordance with the electrical and building codes in effect in your area.

- 1 - Connect the thermostat ONLY to a 120 VAC to 240 VAC power source and respect the load limits.
- 2 - Protect the heating system with appropriate circuit breakers or fuses.
- 3 - Clean the thermostat regularly to remove accumulated dirt. DO NOT use liquid to clean the ventilation openings of the thermostat.
- 4 - DO NOT install the thermostat in a place where it could get wet or on an exterior wall. However, you can install it on insulated interior walls. To avoid any risk of overheating, leave a clearance of at least 12 in. around the thermostat so that it is adequately ventilated.
- 5 - Also make sure not to obstruct the ventilation grilles at the bottom and top of the thermostat housing. Clogged grilles can cause the thermostat to overheat and interfere with its operation.

WARNING: High voltage. Switch off the power before installation and maintenance.

NOTE: Stelpro reserves the right to modify its product without notice to improve its operation. Therefore, the instructions in this guide may not apply exactly to your thermostat model. Refer to the Stelpro website for the most recent documentation. Your product, including its LCD screen, name and packaging, may also be different from the one presented in this manual.

BEFORE YOU GET STARTED

WHERE TO SET UP YOUR HUB

With a minimum amount of planning, you can optimize the Allia mesh network and ensure good communication between devices. The hub allows you to manage the Allia thermostats and other Allia-compatible connected objects in your home. Install the hub in the most **central location** possible to boost communication between the various rooms. The more Allia-compatible connected objects you have in your home, the more they will act as Zigbee signal repeaters to allow good communication between thermostats and connected objects.

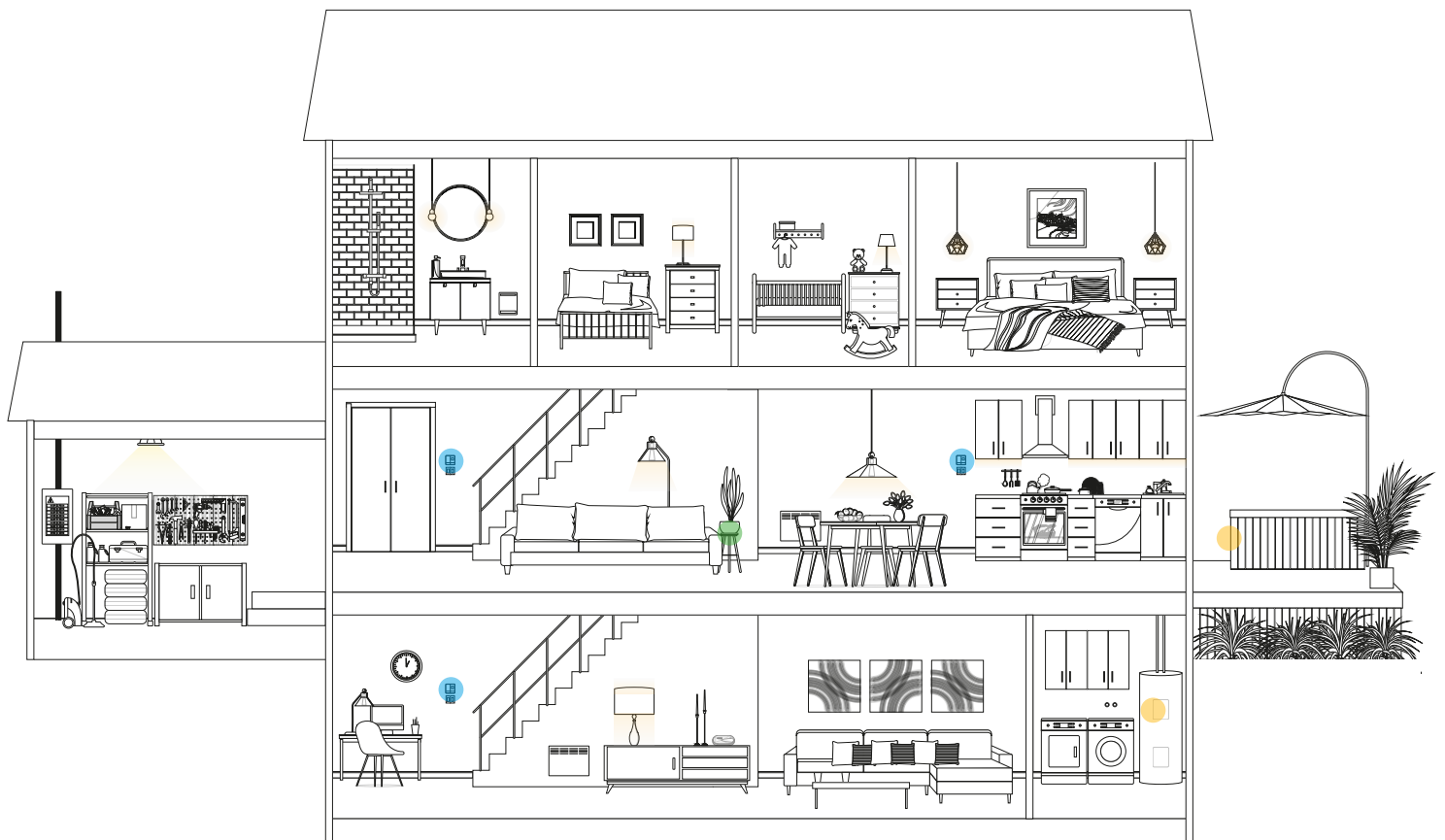

HUB



THERMOSTATS



COMPATIBLE CONNECTED OBJECTS

WHERE TO INSTALL YOUR THERMOSTATS

- 1 -** Install an Allia thermostat in every room where you want to control the temperature.
- 2 -** Install the thermostat about 5 ft above the floor, on an inside wall facing the heating system. The thermostat must be placed on an electrical box.
- 3 -** The space in front of the thermostat must be completely clear for it to operate optimally. Do not install the thermostat behind a piece of furniture or a curtain, for instance.

WARNING: To avoid overheating, leave at least 12 in. clearance around the thermostat to ensure adequate ventilation.

- 4 -** To avoid inaccurate temperature readings, **do not install the thermostat:**
 - | near a window or door that leads outdoors.
 - | in a place exposed to direct light or heat from the sun, a lamp, a fireplace or any other heat source.
 - | near an air vent.
 - | near pipes, concealed ducts or a chimney.
 - | in a place with poor air circulation, such as behind a door.
 - | in an area with a high dust concentration.
 - | in a place where there are frequent drafts, such as the top of a staircase.

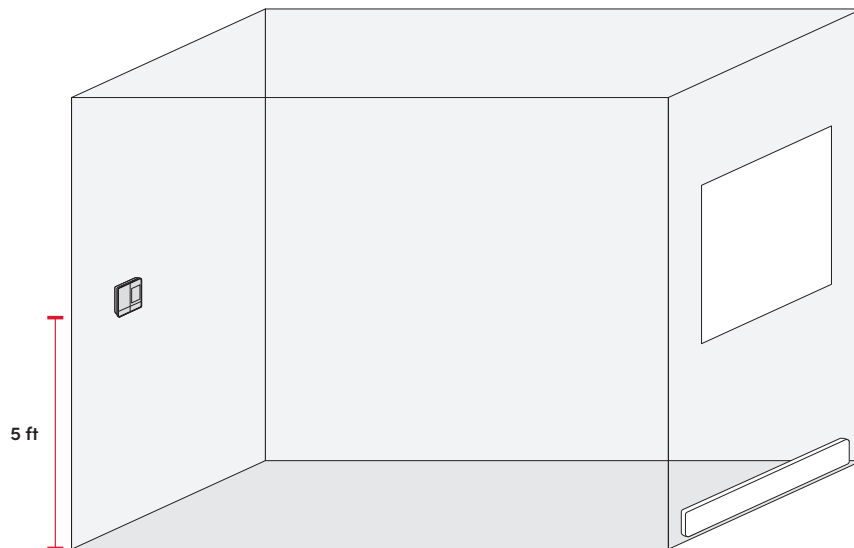

INSTALLATION

WARNING: The thermostat must be installed by a certified electrician.

1

TURNING THE POWER OFF

To protect yourself against electric shock, switch off the power to the wires at the electrical panel. Then, make sure the wires are no longer powered, e.g., checking that the heating system remains off even when the setpoint temperature is higher than the room temperature (mechanical thermostat).

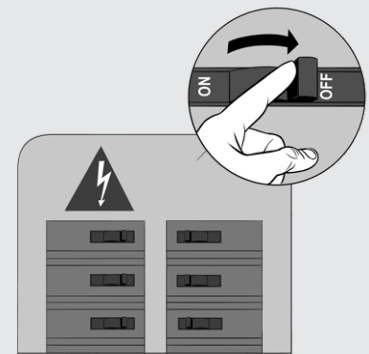

2

ATTACHING THE MOUNTING PLATE

- 1 - Loosen the screw at the base of the Allia thermostat, without completely removing it, until the thermostat and the mounting plate are no longer attached. Slide the mounting plate down and away from the thermostat.
- 2 - Using the mounting screws provided (2), attach the Allia thermostat mounting plate to the electrical box.
- 3 - Pass the power supply wires through the large opening in the centre of the mounting plate.

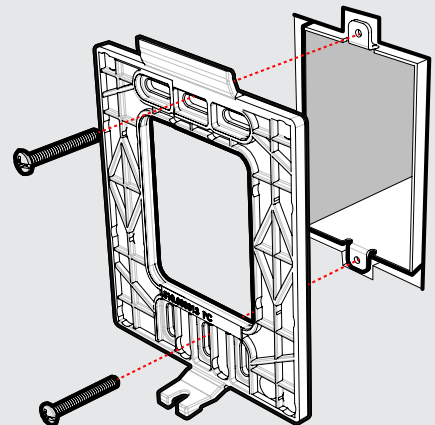

NOTE: You can place the mounting plate to the left, centre or right of the electrical box according to your needs (see image). Make sure that the mounting plate is straight so that the thermostat is also straight.

CONNECTING THE ELECTRICAL WIRES

- 1 - Using the supplied connection caps,* connect the Allia thermostat wires to those of the heating system and power supply wires according to the corresponding connection diagram.
- 2 - Tighten the caps on the wires to make sure the connection is secure.
- 3 - Then, place all the wires in the electrical box.

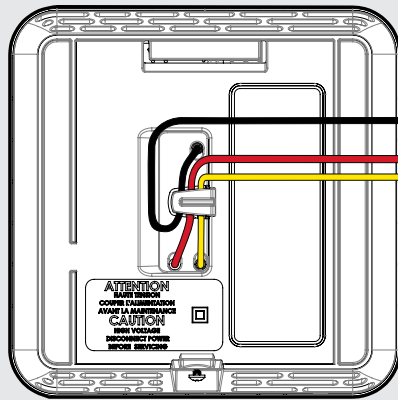

L1 Black
L2/N Red
LD Yellow

The direction of the connection is important since the thermostat wires are polar.

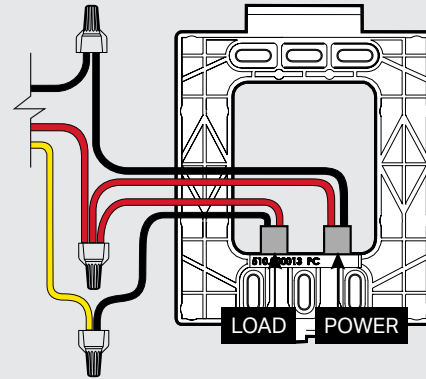

For baseboards, convectors and fan heaters

3 CONNETORS
UNIVERSAL
CONNECTION

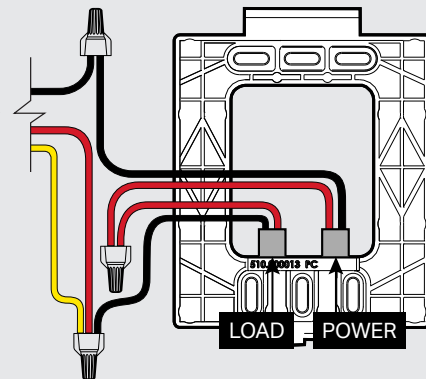

For baseboards and convectors only

3 CONNETORS
ALTERNATIVE
CONNECTION

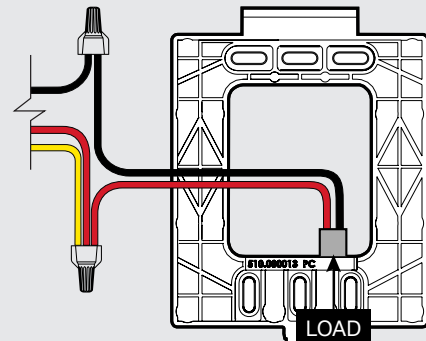

For baseboards and convectors only

2 CONNETORS
CONNECTION

WARNING: Improperly connected electrical wires are a fire hazard.

*If the power supply wires are made of aluminium, use CO/ALR connection caps instead (not supplied).

4

ATTACHING THE THERMOSTAT TO THE MOUNTING PLATE

- 1 - Make sure that the thermostat's ventilation openings are clean and unobstructed.
- 2 - Align the notch at the top of the thermostat with the notch on the mounting plate.
- 3 - Then, place the thermostat on the mounting plate, taking care not to pinch the wires between the device and the mounting plate.
- 4 - Tighten the screw at the base of the thermostat to hold it securely in place.

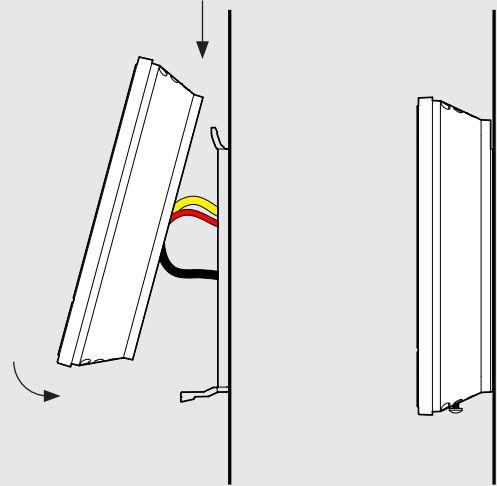

5

TURNING THE POWER BACK ON

Restore power to the heating system and thermostat. Then, make sure that the thermostat turns on.

If the thermostat does not turn on, press one of its buttons. The thermostat should turn on. If it does not, see "Troubleshooting" on page 19.



The thermostat will display three (3) preferences that should be configured before use. See the "SETUP" section on page 16 for more details.

MENU 20
TEMPERATURE FORMAT

MENU 30
HEATING MODE

MENU 31
LOBBY MODE

If the temperature is below 32°F, the home screen will display "LO".
If the temperature exceeds 122°F, the display will display "HI".

THERMOSTAT INTERFACE

The Allia thermostat's three-button interface puts 360° comfort at your fingertips.

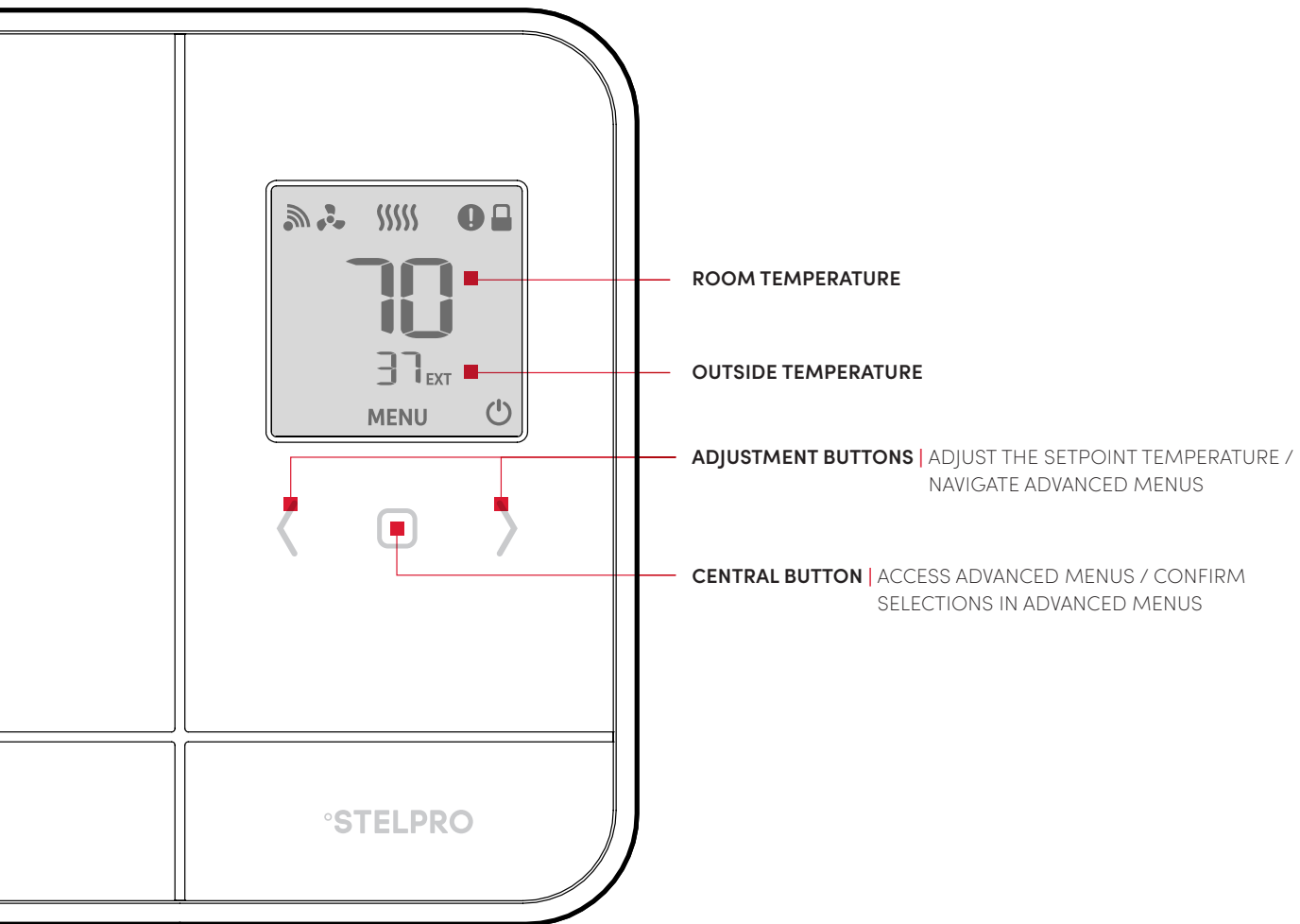

MEANING OF THE ICONS



ZIGBEE CONNECTION ESTABLISHED



HEATING MODE



HEATING INTENSITY



DEVICE HAS OVERHEATED



LOCKED KEYPAD



LOW SETPOINT TEMPERATURE OR OPEN WINDOW
DETECTION (FLASHING ICON)

MENU

ADVANCED MENU INDICATOR

USE

NAVIGATING THE ADVANCED MENUS

Here are the steps to access the advanced menus and their options:

- 1 -** From the home screen, press the central button for three (3) seconds to access the advanced menu. The first menu that appears is the Zigbee connection menu.
- 2 -** Press the central button again to go to the next menu. The current value will flash, meaning that it can be changed.
- 3 -** Use the > buttons to choose another option from the displayed menu.
- 4 -** After selecting an option, press the central button to confirm the selection. The selected value flashes rapidly for two (2) seconds and is displayed continuously once saved. Then, the thermostat automatically goes to the next menu.
- 5 -** Press the central button for three (3) seconds to exit the advanced menu and return to the thermostat's home screen.

NOTE: After 30 seconds of inactivity, the selected option will automatically be saved (except for options in Menu 10 - Zigbee connection) and the thermostat will return to the home screen.

ADVANCED MENUS

MENU 10 | ZIGBEE CONNECTION (OFF = NOT CONNECTED; ON = AUTOMATIC PAIRING; ZIGBEE CHANNEL NUMBER)

MENU 20 | TEMPERATURE FORMAT (°C OR °F)

MENU 30 | FAN HEATER HEATING MODE (ON OR OFF)

MENU 31 | LOBBY MODE (ON OR OFF) → DISPLAYED ONLY IF THE HEATING MODE IS SET TO FAN HEATER

MENU 40 | KEYPAD LOCK/UNLOCK (ON OR OFF)

MENU 50 | OPEN WINDOW DETECTION (ON OR OFF)

MENU 60 | BACKLIGHT INTENSITY WHEN THERMOSTAT IS INACTIVE (OFF, LO, HI)

MENU DEF | RESET TO DEFAULT



NAVIGATING THE TECHNICAL MENUS

Access the technical menus from the home screen by pressing the central button  for ten (10) seconds.

After three (3) seconds, the advanced menus will be displayed (menu 10). Continue to press the button until the technical menus appear.

TECHNICAL MENUS

MENU T1 | THERMOSTAT VERSION

MENU I00 TO I17 | ZIGBEE INSTALLATION CODE



MENU T2 | ZIGBEE VERSION

MENU A0 TO A7 | MAC ADDRESS

MENU T3 | THERMOSTAT CONTROL CODE





ADJUSTING THE SETPOINT TEMPERATURE

By default, the setpoint temperature is set to 70°F. To change the setpoint temperature, use the   buttons on the home screen.

The  button will increase the setpoint temperature 1°F at a time.

The  button will lower the setpoint temperature by 1°F at a time.

If the thermostat needs to activate the heating system to reach the setpoint temperature, the  icon will indicate the intensity at which the heating system is operating.

The thermostat keypad must be unlocked (the  icon will not appear on the screen).

If the thermostat is part of the Allia ecosystem, the temperature will adjust automatically if a scene or program for this thermostat launches.

CONNECTION

ALLIA HUB

To create your Allia network, you must connect your thermostats to the Allia hub through its Zigbee network. Install all your thermostats before connecting them. Make sure to connect the thermostat closest to the Allia hub first, and then connect the other thermostats, progressively working away from the hub.

You may need to install other Allia-compatible thermostats or connected objects to bypass obstacles or boost the Zigbee signal.



CONNECTING VIA THE ALLIA APP

To connect the thermostat to the Allia hub using the Allia app, your hub must be connected to a Wi-Fi network.

- 1 -** From the ALLIA app's device page, click **+** to add a new device.
- 2 -** Select the type of device you want to add by clicking on "Thermostat, light, ...". The hub indicator light turns blue and flashes slowly.
- 3 -** On the thermostat, go to menu 10 and select automatic connection (ON).
- 4 -** Touch the central button to confirm the selection. The  icon flashes quickly while the thermostat searches for the channel. The Zigbee channel will be displayed when the connection is established.

Once the thermostat is connected to the hub's Zigbee network:

- | the  icon will appear on the thermostat's home screen.
- | the Allia app will indicate that the thermostat has been connected successfully and the thermostat will appear in the app.

You can now replace the default name of each thermostat with a meaningful name that is easier to recognize (e.g., Bathroom).



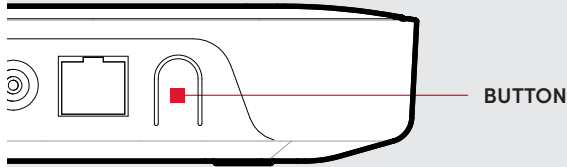

CONNECTING VIA THE ALLIA HUB



- 1 - Press the button on the hub; the indicator light on the hub will turn blue and flash slowly.
- 2 - On the thermostat, go to menu 10 and select automatic connection (ON). The  will flash quickly while the thermostat searches for the channel.

The Zigbee channel will be displayed when the connection is established.

- 3 - When the  icon disappears and you see °F on the screen, press the central button  for three seconds. The display stops flashing and the room temperature will be displayed. The  will once again be visible in the upper left corner.
- 4 - The connection process is complete. Repeat the procedure for each thermostat.

CONNECTING TO ANOTHER ZIGBEE NETWORK

If you do not have an Allia hub, but your residence already has a Zigbee network, you can connect the thermostat to this network. However, you will not be able to use the Allia application or benefit from the Allia system's features.

- 1 - Set the thermostat controller to Zigbee connection mode.
- 2 - On the thermostat, go to menu 10 and select automatic connection (ON).

The  icon flashes quickly while the thermostat searches for the channel. The Zigbee channel will be displayed when the connection is established.

- 3 - Press the central button  to confirm the selection.

Once the thermostat is connected to the Zigbee network, the  icon will be displayed on the home screen.

NETWORK DETECTION

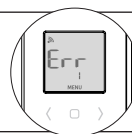

NO NETWORK DETECTED

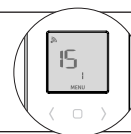

CONNECTED ESTABLISHED

SETUP

The first time you start the thermostat, set up the three basic preferences. The thermostat will display temperature format and heating mode options and Lobby mode options if the heating mode is set to Fan Heater. You must also set up the Zigbee connection if you want to connect your thermostat to an Allia hub. Install all your thermostats before connecting them to the hub.

20

TEMPERATURE DISPLAY UNIT

By default, the temperature is displayed in degrees Celsius. You can also display the temperature in degrees Fahrenheit.

- 1 - Go to menu 20.
- 2 - Use the $\langle \rangle$ buttons to select °C or °F.
- 3 - Press the central button \square to confirm the selection.

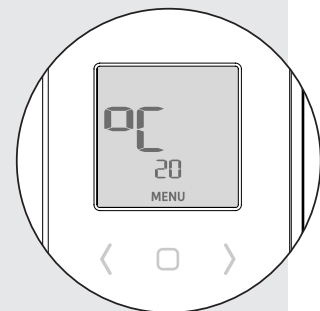

30

HEATING MODE

The heating mode corresponds to the type of heating system that the thermostat controls: baseboard/convector or fan heater.

- 1 - Go to menu 30.
- 2 - Use the $\langle \rangle$ buttons to select baseboard/convector mode (OFF) or fan heater mode (ON).
- 3 - Press the central button \square to confirm the selection.

When fan heater mode is selected, the  icon is displayed on the thermostat's home screen.

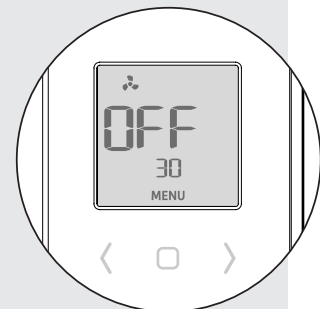

LOBBY MODE

- 1-** Go to menu 31.
- 2-** Use the $\langle \rangle$ buttons to select Standard (Std) or Lobby (LbY) mode.
- 3-** Press the central button to confirm the selection.

Lobby mode can only be selected if the heating mode is set to fan heater and open window detection is disabled.

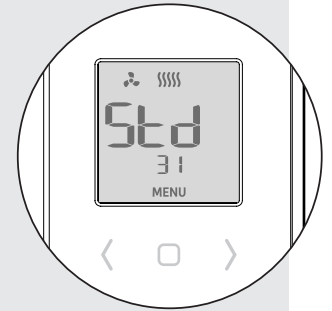

KEYPAD LOCK/UNLOCK

You can lock the thermostat keypad to prevent the setpoint temperature from being changed by mistake. By default, the thermostat keypad is unlocked.

- 1-** Go to menu 40.
- 2-** Use the $\langle \rangle$ buttons to unlock (OFF) or lock (ON) the keypad.

- 3-** Press the central button to confirm the selection.

When the keypad is locked, the  icon is displayed on the thermostat's home screen.

You can change a thermostat's setpoint temperature via the Allia app even when its keypad is locked.

OPEN WINDOW DETECTION

The thermostat can detect if a window is open in the room where it is located. The thermostat will then automatically adjust the setpoint temperature to 45°F to avoid heating the room unnecessarily.

This option is only available if Lobby mode is set to Standard.

- 1-** Go to menu 50.
- 2-** Use the $\langle \rangle$ buttons to turn open window detection ON or OFF.
- 3-** Press the central button to confirm the selection.

BACKLIGHTING

By default, the thermostat screen lights up when you touch one of the buttons. You can deactivate this function or adjust the intensity of the backlighting.

- 1- Go to menu 60.
- 2- Use the $\langle \rangle$ buttons to turn OFF or change the backlight intensity to HI or LO.
- 3- Press the central button to confirm the selection.

THERMOSTAT RESET

You can reset the thermostat to its default settings.

- 1- Go to the Reset (DEF) menu.
- 2- Use the $\langle \rangle$ buttons to select "Y" and revert to the default values.

- 3- Press the central button to confirm the reset.

The thermostat will reset. This process may take a few seconds.

WARNING: All settings will revert to their default values and the connection to the Zigbee network and hub will be deleted.

TROUBLESHOOTING



COMMON PROBLEMS

The following table lists the most common problems and alerts you may encounter with your thermostat. If your problem is not listed in this table, or if the proposed solution does not solve the issue, please visit our support site or contact our customer service team:

www.stelpro.com/en/allia/support

1-844-STELPRO (783-5776)

elec.tech@stelpro.com

PROBLEM	SOLUTION
 flashing	The heating system is overheating. Inspect your heating system and replace it if it is defective.
 flashing	The thermostat has detected that a window is open. Close the window or deactivate the open window detection. See page 17.
 flashing	There is an issue with the thermostat's Zigbee network. Reset the thermostat and reconnect it to the hub. See page 18.
LO	Room temperature is below 32°F. Heating will remain active until the temperature reaches the setpoint temperature. LO disappears when the temperature reaches 32°F.
HI	Room temperature is above 122°F. Heating will remain inactive. HI disappears when the temperature reaches 122°F.
--	The thermostat cannot measure the temperature (defective temperature sensor). Replace the thermostat. NOTE: This alert may also be displayed temporarily immediately after a reset. It should disappear automatically after about 10 seconds.

PROBLEM	SOLUTION
The thermostat is hot.	Even when the thermostat is operating normally, the thermostat housing can become warm to the touch. This does not affect the thermostat's efficiency or operation.
The heating system is operating continuously even once the setpoint temperature has been reached.	<p>Make sure the thermostat wires are properly connected (see page 9).</p> <p>NOTE: The thermostat can also control low power heating to maintain the temperature once the setpoint temperature has been reached.</p>
The heating is not operational even though the thermostat indicates otherwise.	Make sure the thermostat wires are properly connected (see page 9).
The thermostat does not switch on after being installed.	<p>Make sure the thermostat wires are properly connected and that the caps are tightened securely (see page 9).</p> <p>Make sure the circuit breaker allocated to the heating system in the electrical panel is set to OFF. If the heating system has a switch, make sure it is ON.</p>
The thermostat does not display the correct room temperature.	Make sure there are no drafts or heat sources near the thermostat.
The fan heater switches on and off frequently.	Set the heating mode in menu 30 to ON.
The thermostat's buttons do not respond, except for advanced menu access.	The thermostat is locked. Deactivate lock mode.
The thermostat does not connect to the Zigbee network.	Your thermostat may be too far away from another thermostat in the network. Make sure that the thermostats that are located between the thermostat and hub are installed and connected to the Zigbee network. Also, make sure that the hub is in connection mode.

TECHNICAL SPECIFICATIONS

DEFAULT VALUES

Setpoint temperature	70 °F
Zigbee connection	Disconnected
Temperature display format	° Fahrenheit
Heating mode	Electric baseboard
Locking	Keypad unlocked
Open window detection	Disabled
Backlighting	Disabled

ELECTRICAL CHARACTERISTICS

Supply voltage	120 - 240 VAC, 60 Hz
Minimum load	Resistive only 150 W at 120 VCA, 60 Hz 260 W at 208 VCA, 60 Hz 300 W at 240 VCA, 60 Hz
Maximum load	Resistive only 2000 W at 120 VCA, 60 Hz 3400 W at 208 VCA, 60 Hz 4000 W at 240 VCA, 60 Hz

CONNECTIVITY

Zigbee	IEEE 802.15.4 protocol
--------	------------------------

TEMPERATURE DISPLAY

Actual measured temperature	32°F to 122°F
Temperature display increments	1°F
Setpoint temperature	41°F to 86°F
Setpoint temperature increments	1°F

STORAGE CONDITIONS AND USE

Storage temperature	-40°F to 122°F
Operating temperature	-4°F to 122°F LCD monitor efficiency may decrease below 32°F
Relative humidity	5% to 95% without condensation



WARRANTY

This device is guaranteed for **three (3) years**. If it stops working properly during this period, please return it to the place you purchased it with a copy of your invoice or contact our customer service department (with a copy of your invoice on hand). For this warranty to be valid, the device must be installed and used according to the guidelines outlined in this guide. If the installer or user modifies the device in any way, they will be held responsible for any damage resulting from this modification. The warranty is limited to factory repair or replacement of the unit and does not cover disconnection, transportation and installation costs.

NEED HELP?

CONTACT STELPRO CUSTOMER SERVICE.

WWW.STELPRO.COM

CONTACT@STELPRO.COM

1-844-STELPRO